



**S.I.A.I. MARCHETTI**

SESTO CALENDE (LAGO MAGGIORE) ITALIA

*Riviera*

**FN. 333**

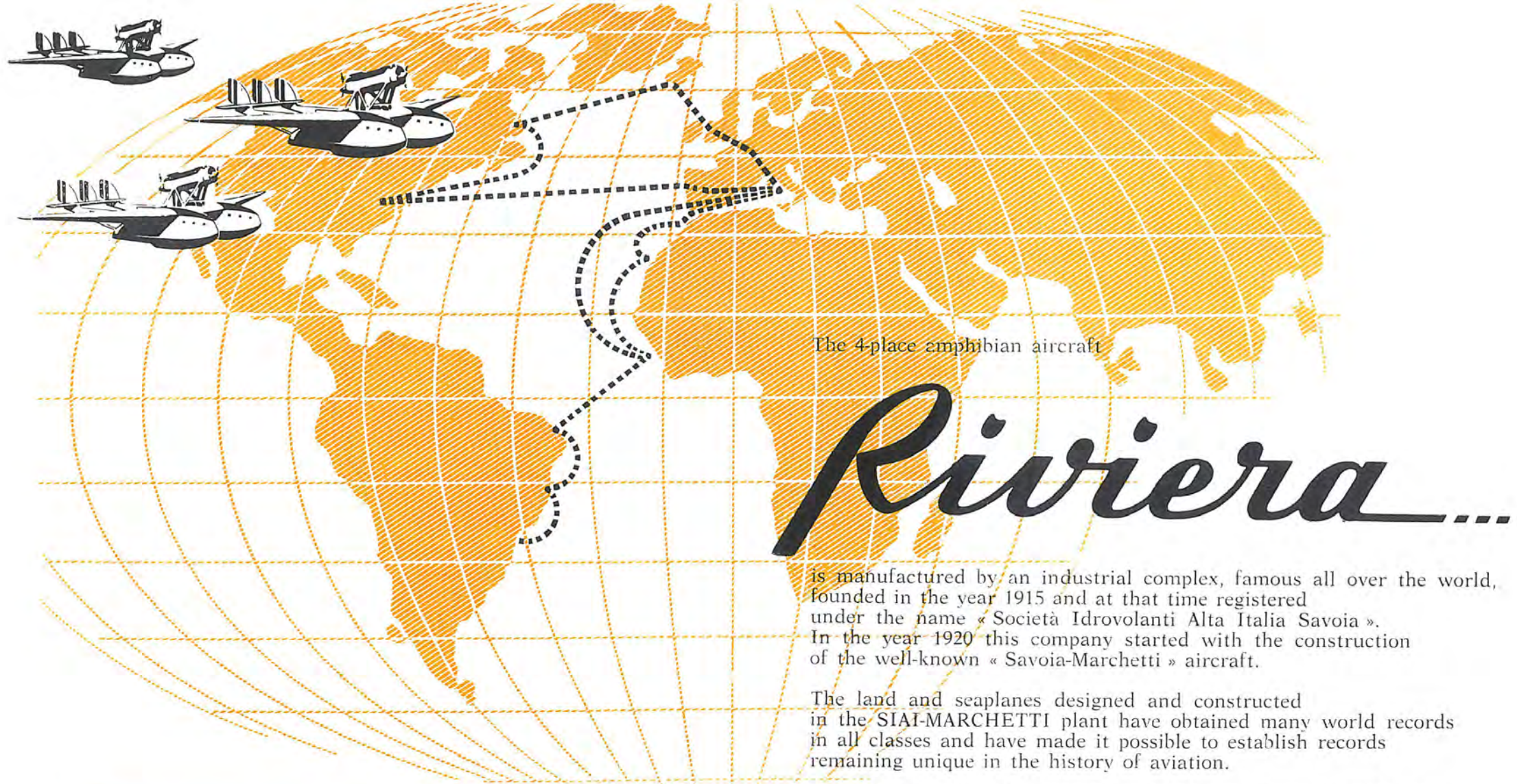

The 4-place amphibian aircraft

# Riviera...

is manufactured by an industrial complex, famous all over the world, founded in the year 1915 and at that time registered under the name « Società Idrovolanti Alta Italia Savoia ». In the year 1920 this company started with the construction of the well-known « Savoia-Marchetti » aircraft.

The land and seaplanes designed and constructed in the SIAI-MARCHETTI plant have obtained many world records in all classes and have made it possible to establish records remaining unique in the history of aviation.

The industrial complex SIAI has taken up once more, besides its mechanical production, the aeronautical construction participating actively in the integrate production of the aircraft F 104; while another great activity consists in the overhaul and repair of all types of aircraft, especially multi-engine transport aircraft of the Italian Air Force, the United States Air Force and the N.A.T.O.

This long and continuous experience in the aeronautic field, in the construction of all aircraft types, and above all in the design and construction of seaplanes gives an absolute guarantee for the fine workmanship and highest quality, main features of the amphibian RIVIERA.



The amphibian aircraft

# Riviera

is all metal, 4-place with propulsive engine. Its high-wing, tail boom structure has been carefully studied, in order to provide for perfect land and water performance.

The main advantages of this type structure are, besides the fine and wellknown high-wing characteristics, the possibility to have an increased propulsive propeller efficiency and at the same time to keep the empennage away from the water. Last but not least, the advantage of the most efficient placement of two fins must be mentioned, which give the aircraft its excellent stability and maneuvering characteristics.

The principal feature of the RIVIERA is of course the realization of its configurations on land and water.

It is equipped with a retractable landing gear and retractable floats. The landing gear retracts into the fuselage, giving a perfect line and appearance to the aircraft in flight (very unusual in small amphibians), while the floats retract in the wing tips making an integral part of them. This gives an excellent shape to the wing, and besides this eye-appeal, it eliminates the considerable passive resistance of such floats, which often becomes a handicap in the speed performance of amphibian aircraft.

In conclusion it may be said that thanks to the accurate aerodynamic studies, which have been conducted in designing this aircraft, it has been possible to obtain for the very first time, an amphibian which has the flight performances of an excellent class land plane.



# TECHNICAL DATA

## Characteristics ratio:

- Wing loading . . . . . 20.05 lbs sq. ft.
- Power loading . . . . . 13.10 lbs HP.

## Weights:

- Empty weight . . . . . 2,270 lbs.
- Useful load . . . . . 1,000 »
- Total weight . . . . . 3,270 »

## Power plant:

- « CONTINENTAL IO-470-P »
- Take-off power . . . . . 250 HP.
- Max. cont. power . . . . . 250 »

## Propeller:

- « HARTZELL » constant-speed reverse pitch pusher airscrew 2-blade or 3-blade

## Cabin dimensions:

- Cabin height . . . . . 47.16 in.
- » length . . . . . 114.00 »
- » width . . . . . 42.12 »
- Door dimensions . . . . . 34.08x35.40 »
- Baggage space . . . . . 15 cu. ft.

## Landing gear:

- Retractable tricycle type
- Wheel track . . . . . 6.43 ft.

## Performances:

- Max speed at sea level . . . . . 177 mph.
- Stall speed with gear down, wing floats up, flaps 45° . . . . . 68 mph.
- Max. recommended Cruise 70 % Rated Power at 8,000 ft. Fuel consumption . . . . . 164 mph. 12.9 Gal hr.
- Normal recommended Cruise 60 % Rated Power at 8,000 ft. Fuel consumption . . . . . 152 mph. 11.1 Gal hr.
- Service ceiling . . . . . 18,500 ft.
- Take-off run (ground) . . . . . 950 »
- Take-off run (water) . . . . . 1,565 »
- Landing roll (ground) . . . . . 660 »
- Landing run (water) . . . . . 625 »
- Normal Range at 8,000 ft. with 4 persons + baggage . . . . . 625 miles

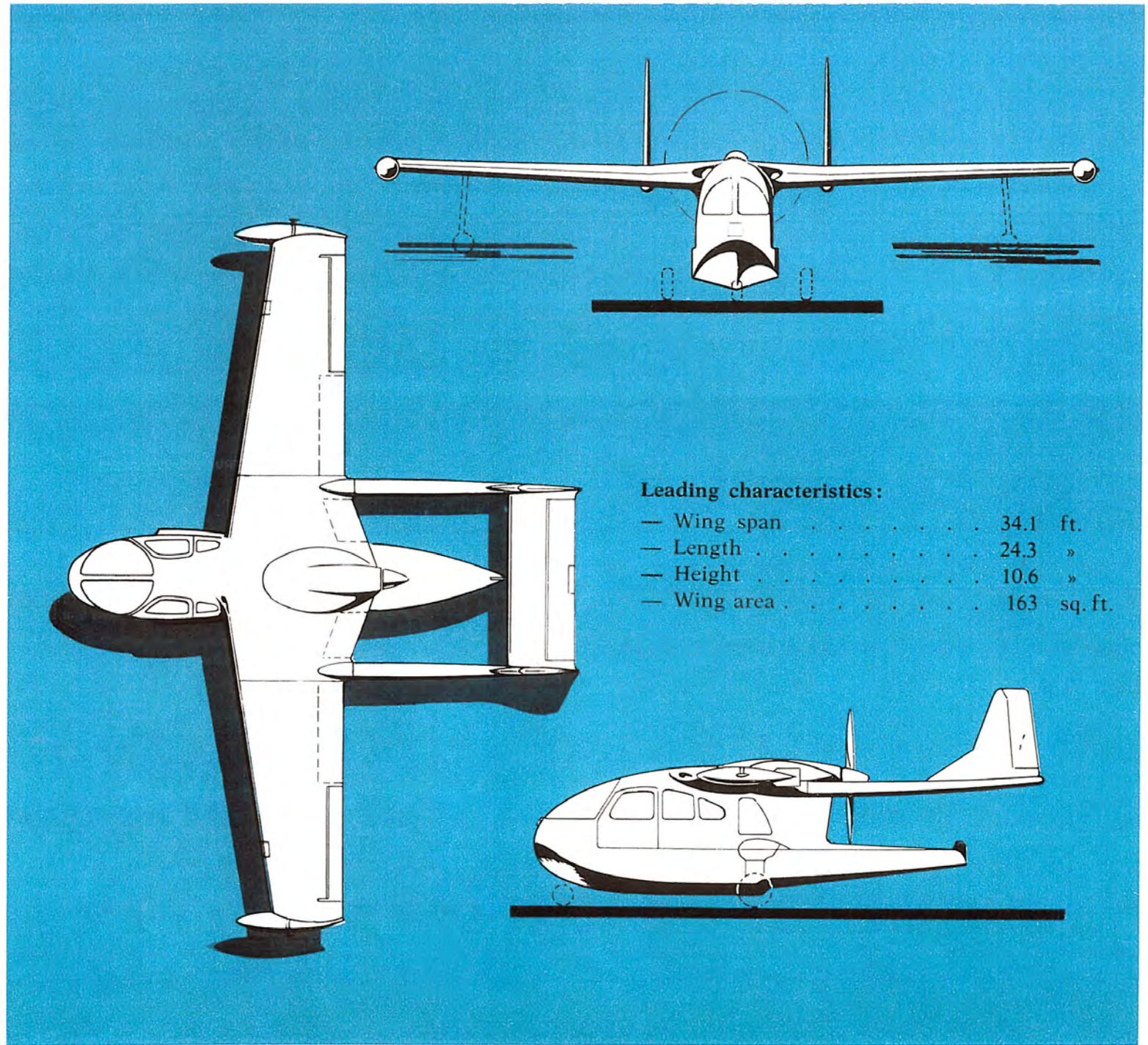

## Leading characteristics:

- Wing span . . . . . 34.1 ft.
- Length . . . . . 24.3 »
- Height . . . . . 10.6 »
- Wing area . . . . . 163 sq. ft.

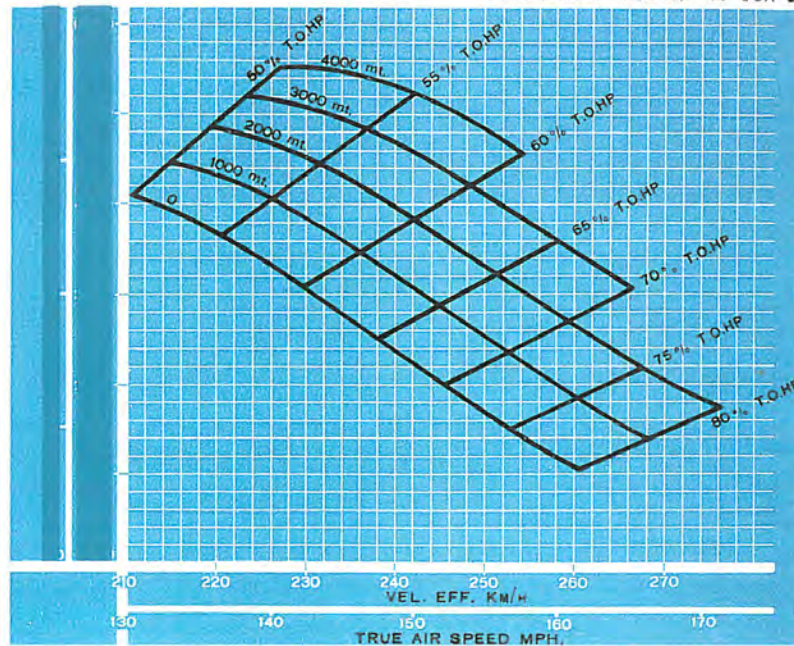
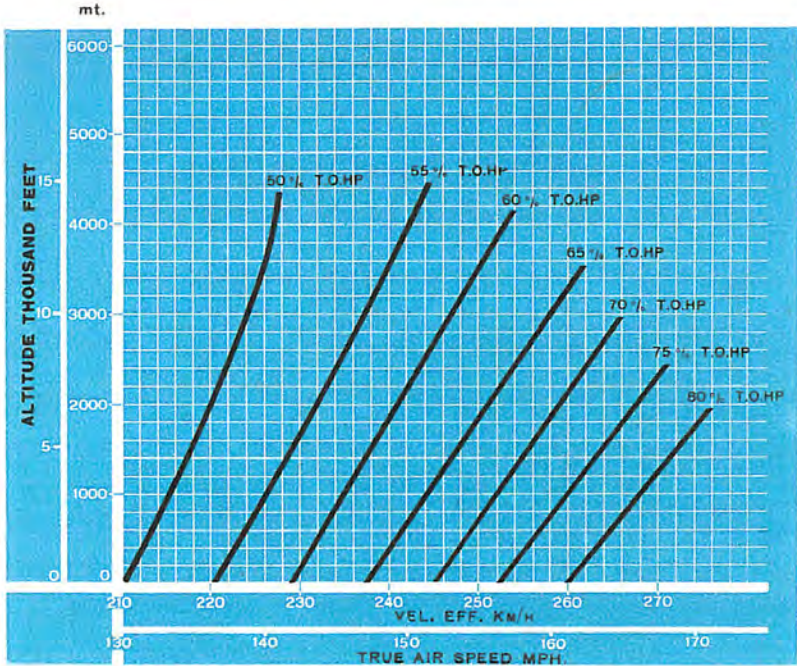

### CLIMBING PERFORMANCES

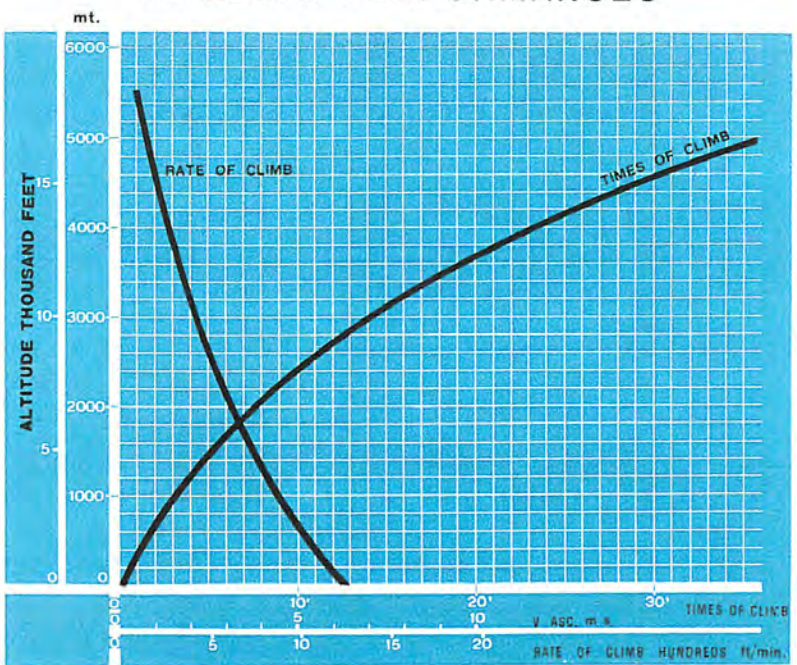

## FLIGHT CHARACTERISTICS

The aircraft  
**RIVIERA FN. 333**  
(licence Nardi)  
is homologated  
by the F.A.A.  
with TYPE  
**CERTIFICATE N° 7AS**

1000  
950  
900  
850  
800  
750  
700  
650  
RANGE MILES

UNITED STATES OF AMERICA  
DEPARTMENT OF COMMERCE  
CIVIL AERONAUTICS ADMINISTRATION  
WASHINGTON

TYPE CERTIFICATE No. 7AS  
NARDI

This certificate, issued to NARDI S.A.  
(Nardi, Italy)

certifies that the following is of proper design, material, construction,  
performance for safe operation, and meets the pertinent provisions  
regulations prescribed by the Civil Aeronautics Board

**FN - 333**

This certificate is of indefinite duration unless suspended or revoked.

Date: October 15, 1938

By Director of the Administration:  
*Robert B. McCreary*  
Chief, Aircraft Engineering - Inspection

The aircraft described herein is authorized as provided by this certificate.

Fig. 3 and 4 of this certificate is punishable by a fine not exceeding \$1000, or imprisonment not exceeding 6 months, or both.

Long Life and Top Efficiency of the RIVIERA  
 guaranteed by its most sturdy construction

- 1) - Elevator
- 2) - Trim Tab
- 3) - Rudder
- 4) - Aileron
- 5) - Flap
- 6) - Water rudder (retractable)
- 7) - Wing floats (retractable)
- 8) - Landing light
- 9) - STALL transmitter
- 10) - Inboard fuel tank
- 11) - Outboard fuel tank
- 12) - Pitot tube
- 13) - Battery
- 14) - Defroster outlet
- 15) - Cabin hot air outlet
- 16) - Aux. hydraulic hand pump
- 17) - Radio space
- 18) - Oil cooler
- 19) - Baggage space
- 20) - Navigation lights
- 21) - Mooring fitting
- 22) - Hydraulic reservoir
- 23) - Engine attachments
- 24) - Augmenter tube
- 25) - Mooring fitting

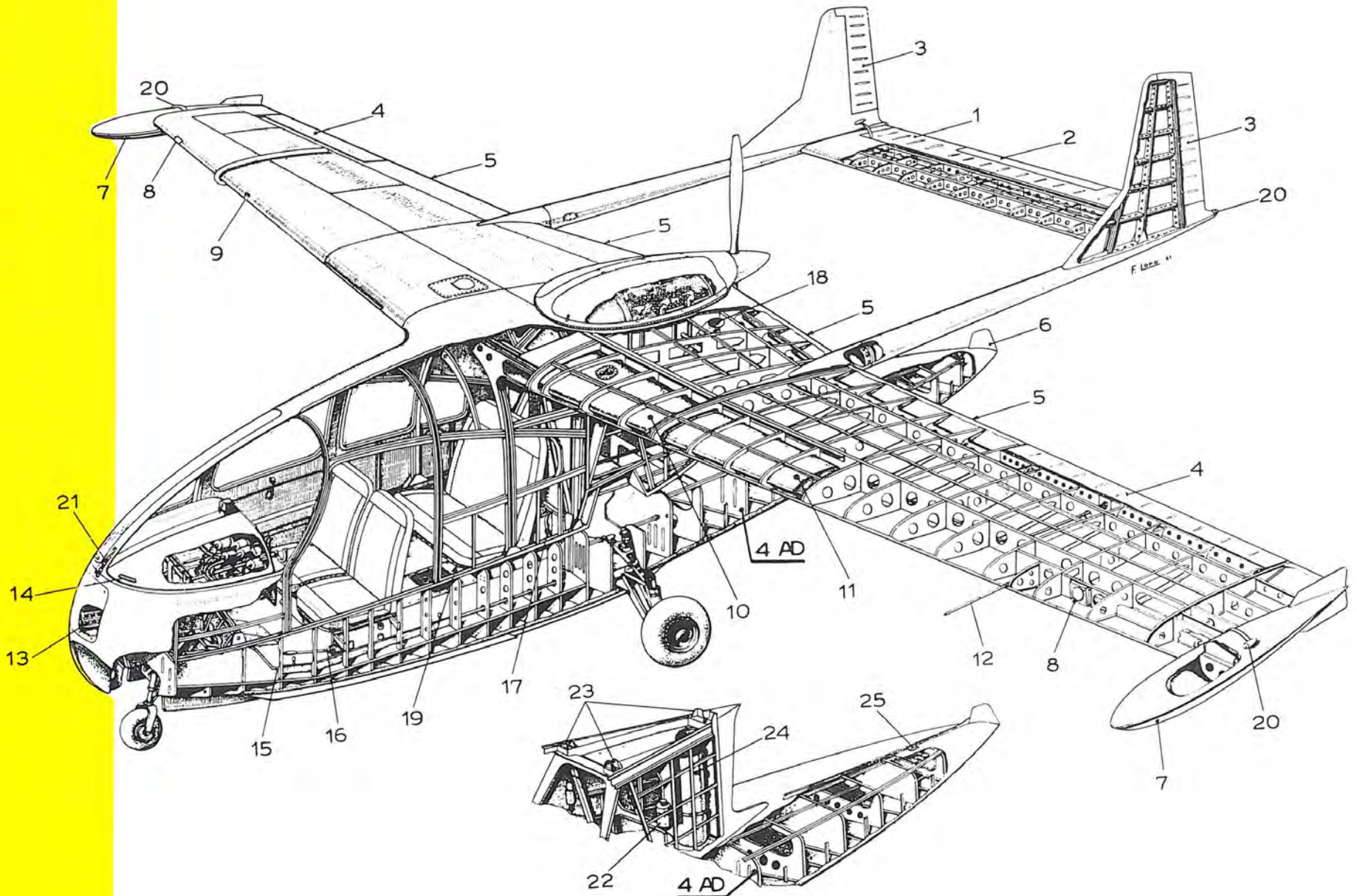

On land  
on water  
the Riviera  
always ready  
to serve you

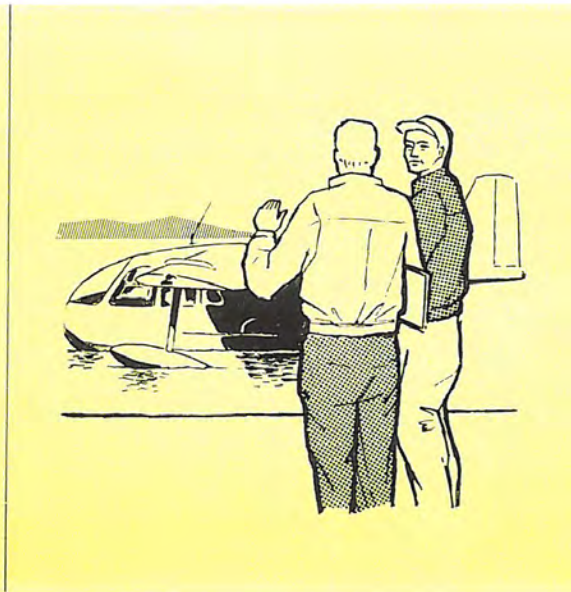
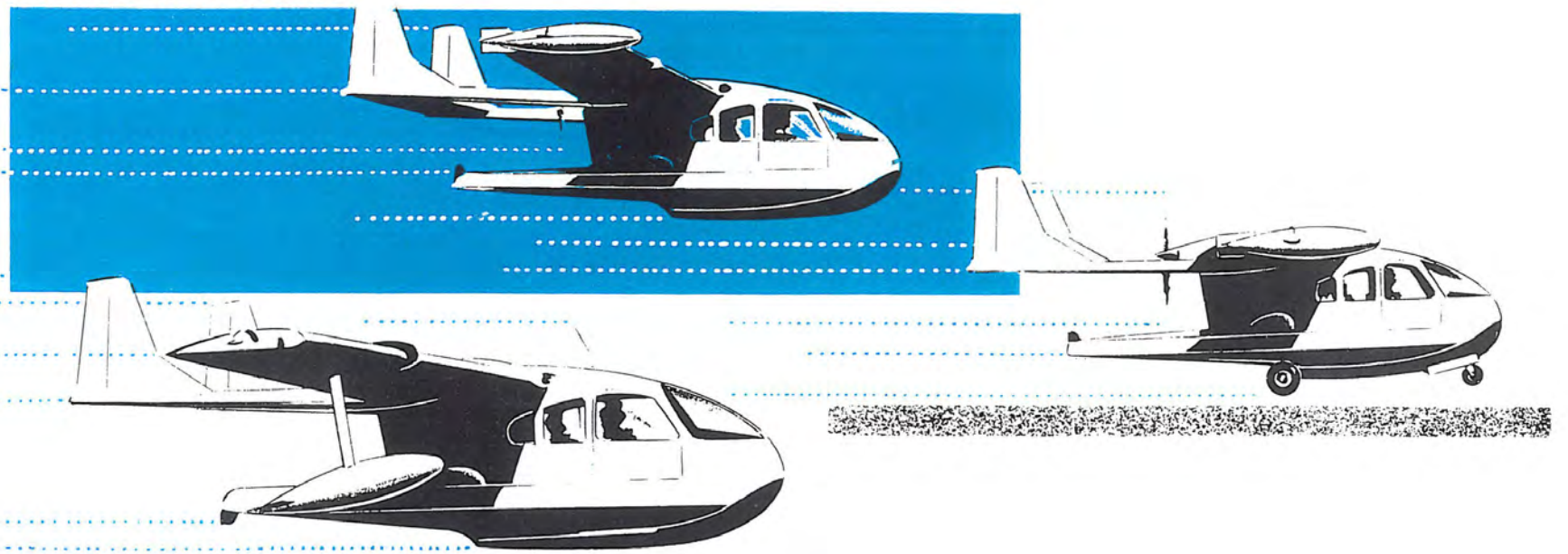

*They did have a 3-bladed prop. off of a Beech plane?  
I flew down to Kertel Prop. and had one installed  
on ours.*

- One of the highlight features of the Riviera:  
Multiple use without need of special equipment!
- The Riviera offers you the possibility to make use, even of small water surfaces,  
with a profoundness of only 3-4 ft for landing and take-off.
- The placement of the nose landing gear permits the aircraft to enter  
and leave the water without need of special auxiliary equipment.  
All you need is a small strip of land with a reasonably flat surface!
- Easy parking in water and on land without need of help, thanks to the propeller  
reverse pitch for backing up and the easy-to-steer nose landing gear!

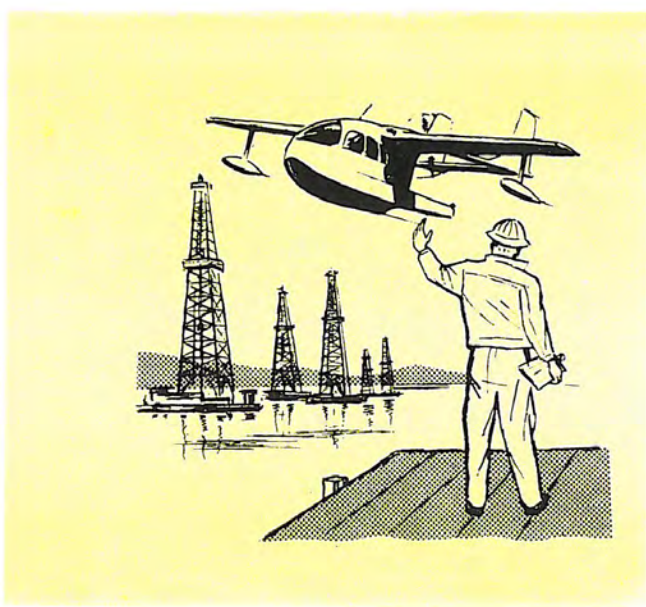



A roomy cabin with 8 windows permits perfect and complete visibility in all directions. The front window visibility is clear due to the absence of the engine and propeller in this area while the high wing construction gives perfect visibility towards the ground.

The sound-proof cabin interior has been obtained by covering all walls with soft material.

The tapestry of the cabin and the seat covers have been carefully studied, by famous Italian specialists, offering perfect color harmony and best quality.

Both front seats are adjustable, while the back of the double rear seat is convertible to give ample baggage space, if necessary. It can also be removed in a moment and without special equipment.

Special attention has been given to avoid corners and surface irregularities, which could endanger the safety of the owners.



#### **TECHNICAL EQUIPMENT & INSTALLATION DATA**

All systems have been studied and realized, making use of the most modern devices.

The FUEL SYSTEM is equipped with 4 fuel tanks, placed in the wing leading edge, with a total capacity of 63 gal. Besides the normal fuel pump, an electrical fuel pump has been installed, for the purpose of feeding the engine in case of failure of the engine driven pump.

The HYDRAULIC SYSTEM comprises the most modern and up-to-date installations, combining highest functional safety and easy-to-handle devices. The hand pump insures a normal extension and downlock of the landing gear under all conditions thanks to its auxiliary system which is completely independent from the main system.

The ELECTRIC SYSTEM of 24 V, DC, provides for the correct and wide range operation of all electrical instruments and for the power necessary to operate numerous radio sets. All circuits are protected by special circuit breakers. A 24 V, 20 AH battery insures safe engine starting even in very cold weather.

The OIL SYSTEM for the engine lubrication is most simple: 2 oil coolers provide for efficient cooling under any operating condition. The engine sump capacity is of 12 quarts.

#### **OPTIONAL EQUIPMENT**

- 1) Co-Pilot's brakes.
- 2) Vacuum System for driving the gyro instruments.
- 3) Various types radio sets.
- 4) Auxiliary cargo door.
- 5) Hull draining system with bilge pump.
- 6) Installation of anticollision rotating beacons.
- 7) Anchor.

**4 SEATS + BAGGAGE SPACE**

Business flying, air taxi, touring

**1 SEAT + FREIGHT SPACE**

Harbor transports for urgent freight, available space for freight 57.5 cu.ft.

**2 SEATS + SPACE FOR STRETCHER**

For first aid - stretcher entrance door dimensions: 3.3 x 5.7 ft.

**DUAL CONTROL FOR SEAPLANE SCHOOL**

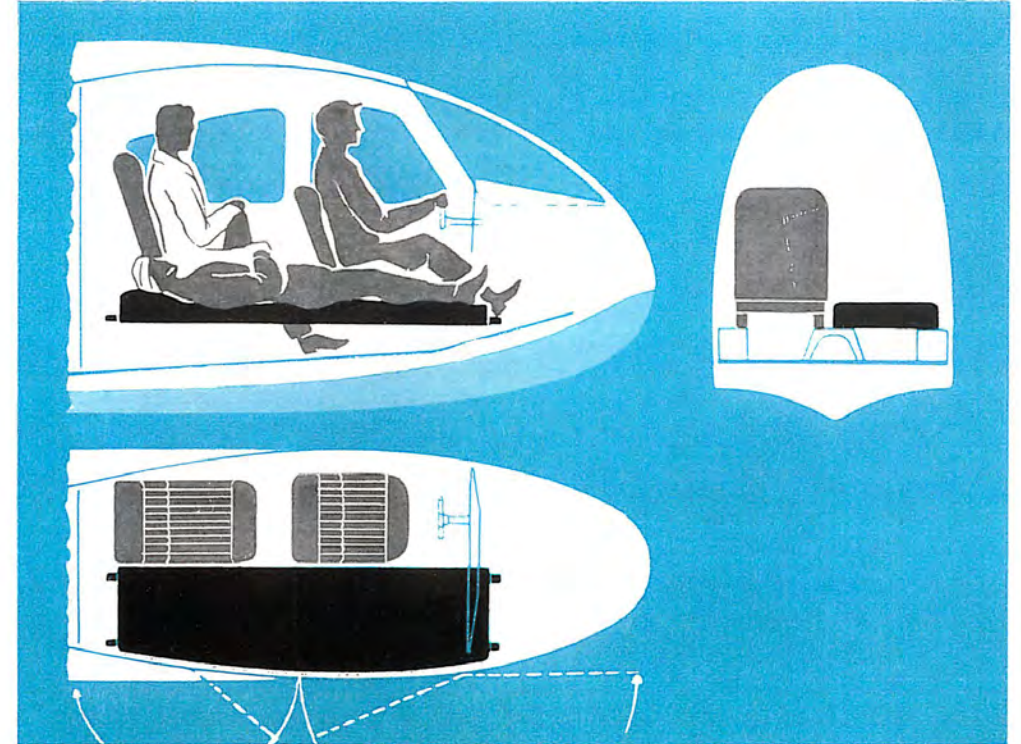
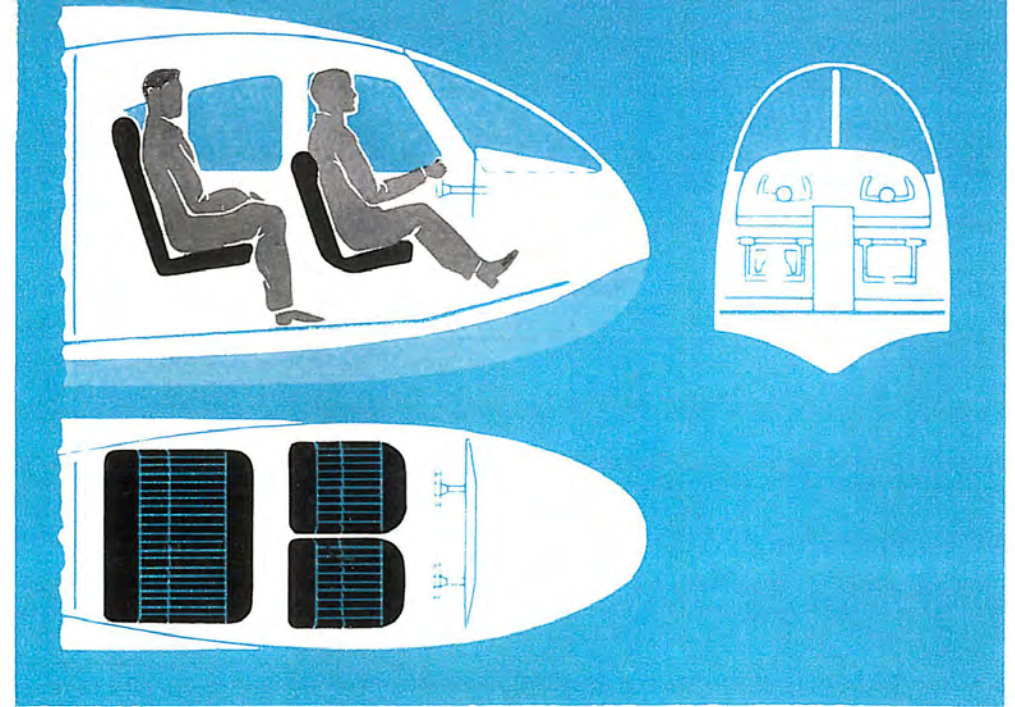

## POWER PLANT

The IO-470 engine is equipped with a continuous flow fuel injection system, assuring highest performance and power under all conditions.

The RIVIERA will be delivered with HARTZELL 2-blade or 3-blade all-metal, constant speed propeller. Either of the above types has a reverse pitch device.

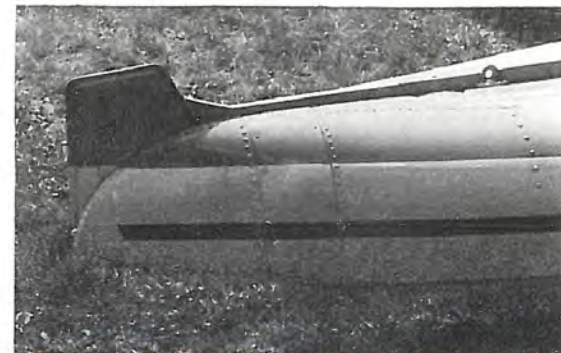
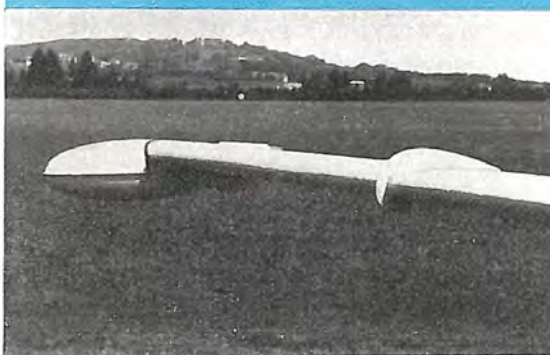
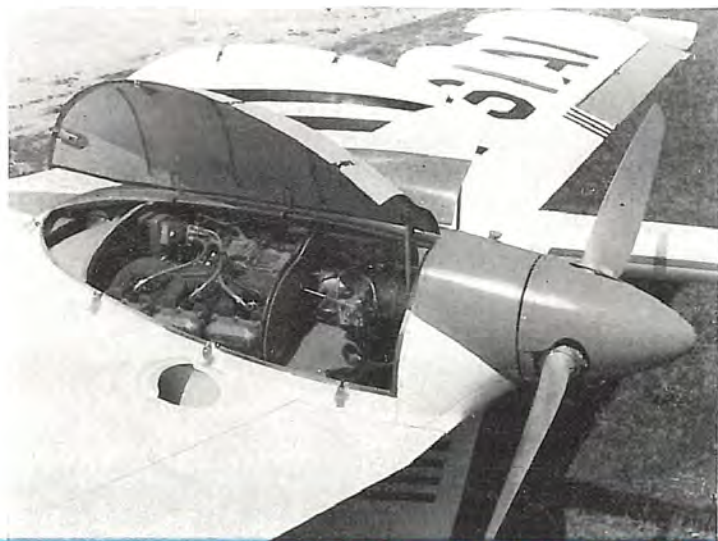

## WING FLOATS

The retractable wing floats are hydraulically operated by two hydraulic actuators and are locked into their retracted position by means of mechanical locks and into their extended position by means of hydraulic devices which are incorporated in the hydraulic actuators.

It is important to note that, although the normal field landing procedure must be performed with the landing gears DOWN and the wing floats UP configuration, the aircraft can also land with the lowered wing floats without meeting any difficulty or danger.

## WATER RUDDER

The water rudder is retractable during flight and can be lowered by pressing a button located on the pilot's wheel.

The lowered water rudder is controlled with the air rudder pedals. When the water rudder begins its retraction travel it becomes disconnected from the rudder pedals and is returned to the center or neutral position by a centering roller and a guide combination, so that the water rudder may always be retracted into its hull housing regardless of the position of the air rudder pedals.

The large water rudder is deep out of the hull wake, so that the maneuverability of the aircraft, while in water, may be compared to that of a normal motorboat.

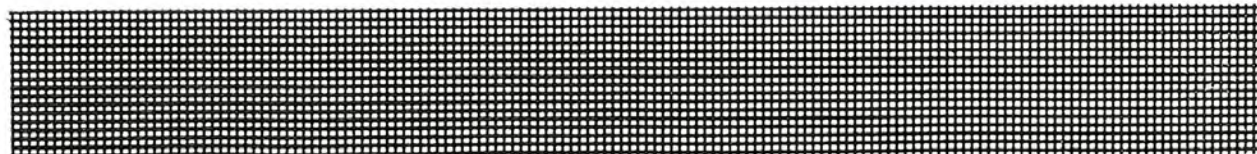

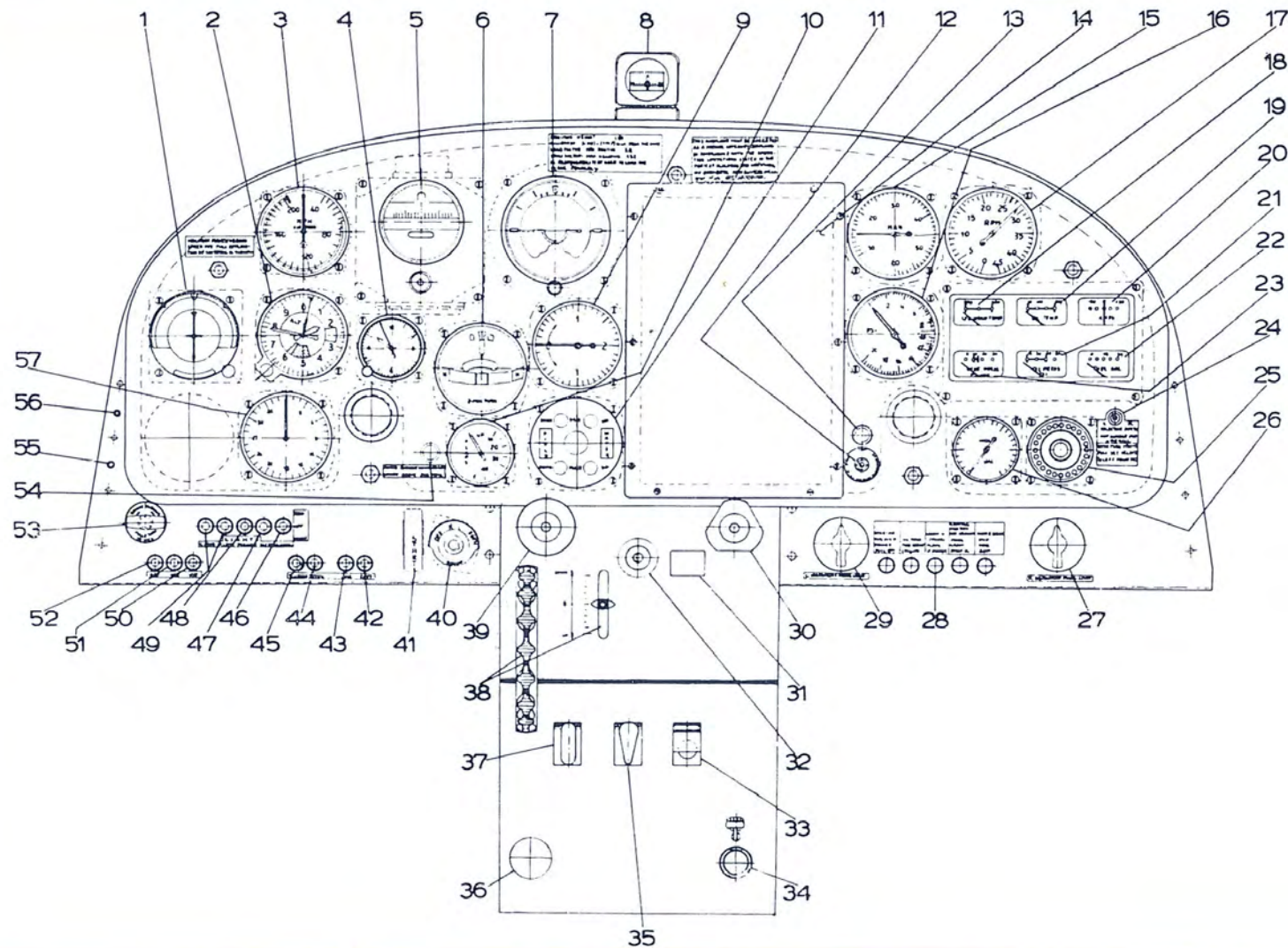

The Riviera panel design is very spacious, permitting the installation of complete instrumentation.

The illumination of all instruments is placed in such manner as to avoid disturbing reflections for the passengers.

- 1) - V.O.R. Indicator
- 2) - Altimeter
- 3) - Airspeed Indicator
- 4) - Clock
- 5) - Directional Gyro
- 7) - Gyro Horizon
- 8) - Compass
- 9) - Rate of Climb Indicator

- 10) - Flap position Indicator
- 11) - Configuration Indicator
- 12) - Fuel Booster Pump Switch
- 13) - Booster Pump Indicator Light
- 14) - Radio Space
- 15) - Manifold Pressure Gage
- 16) - Fuel Pressure Gage
- 17) - Tachometer
- 18) - Fuel Quantity Indicator L. Tank
- 19) - Fuel Quantity Indicator R. Tank
- 20) - Ammeter
- 21) - Oil Pressure Gage
- 22) - Cylinder Head Temperature Gage
- 23) - Oil Temperature Gage
- 24) - Vacuum Gage
- 25) - Stall Warning Horn and Light
- 26) - Hydraulic Pressure Gage
- 27) - R. H. Instrument Panel Light Rheostat
- 28) - Circuit Breakers
- 29) - L. H. Instrument Panel Light Rheostat
- 30) - Propeller Control
- 31) - Nose Gear Indicator
- 32) - Mixture Control
- 33) - Flap Control
- 34) - Hydraulic Unloading CNTL
- 35) - Wing Float Control
- 36) - L. G. Emergency CNTL
- 37) - Landing Gear Control
- 38) - Elev. Trim Tab Wheel & Indic
- 39) - Throttle Control
- 40) - Ignition Switch
- 41) - Starting Switch
- 42) - Battery Switch
- 43) - Generator Switch
- 44) - Pitot Heater Switch
- 45) - Turn and Bank Indic. Swit.
- 46) - Instr. Panel Light Switch
- 47) - Rotating Beacon Switch
- 48) - Navigation Lights Switch
- 49) - Landing Light Switch
- 50) - V.H.F. Switch
- 51) - V.O.R. Switch
- 52) - A.D.F. Switch
- 53) - Parking Brake Handle
- 54) - Water Rudder Indic. Light
- 55) - Head Set Jack
- 56) - Microphone Jack
- 57) - Radio compass Indicator

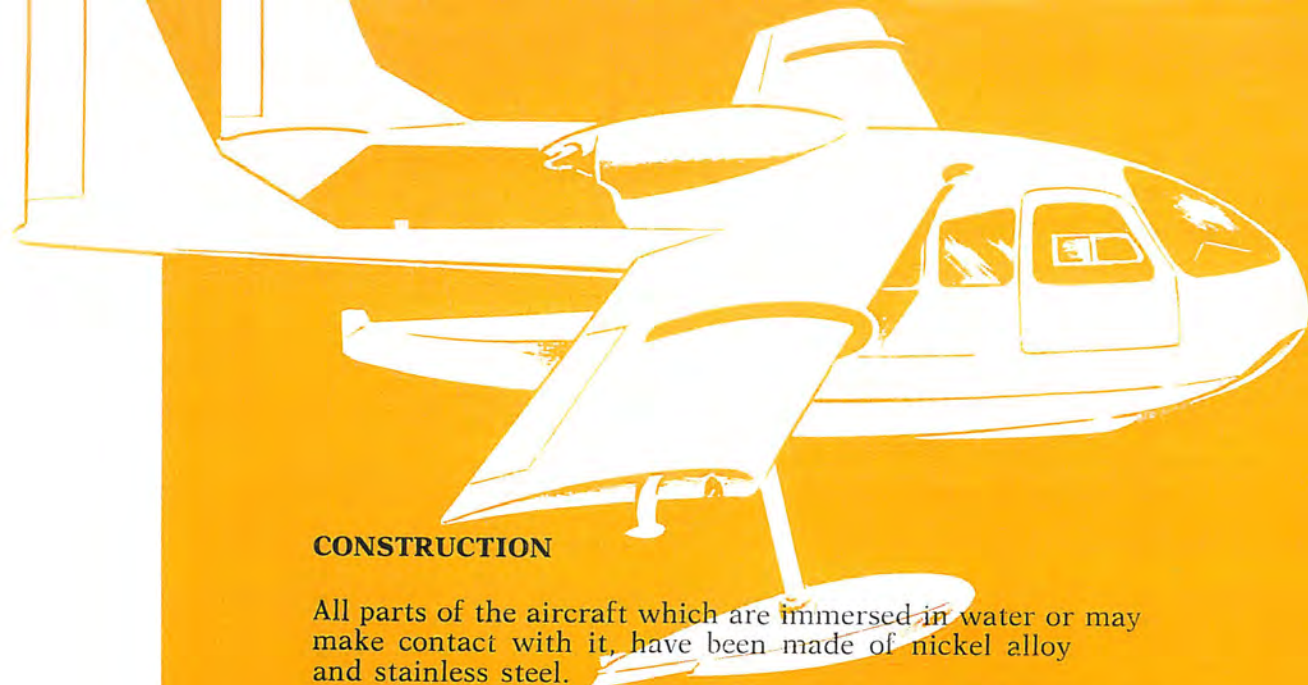

## CONSTRUCTION

All parts of the aircraft which are immersed in water or may make contact with it, have been made of nickel alloy and stainless steel.

The aircraft has been constructed according to the provisions established by the U.S. Navy as far as protection against corrosion is concerned.

All sheet metal parts have been under special chemical anti-corrosion treatment and have been painted with special protective paints as per MIL specifications, resisting to saltwater.

Special care has been exercised in the coupling of unsimilar materials; all joints have been chemically treated and painted prior to their assembly and sealed thereafter.

The control cables are of stainless steel.

The waterproofness of each single hull has been tested on the ground, already during the construction phase, immersing it in special water basins for a period of 12 consecutive hours.

Nuts, bolts, sheet metal, piping, pipe fittings, accessories and installations have been constructed according to the U.S. standards. Any replacement part is therefore easily available on the international market.

Most modern equipment and methods have been employed for the construction of the structures.

An efficient quality control, combined with the long and special competence in the field of aeronautical construction give an absolute guarantee for the construction and craftsmanship of the RIVIERA.

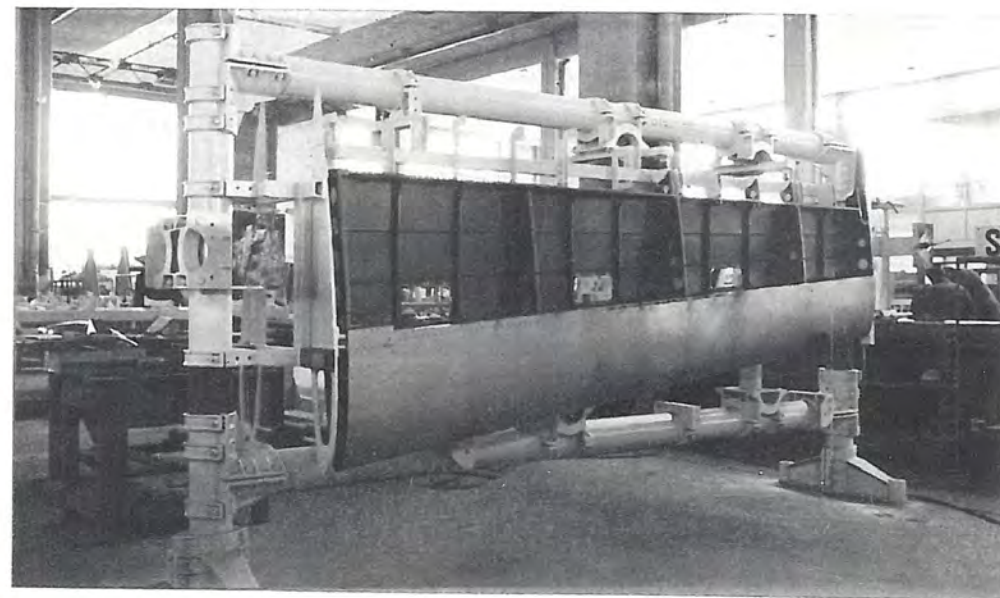

FEDERATION AERONAUTIQUE INTERNATIONALE

# Diplôme de Record

INTERNATIONAL RECORDS ESTABLISHED BY THE AMPHIBIAN SINGLE-ENGINE

## *Riviera* **FN. 333**

CLASS C3 c AMPHIBIAN AIRCRAFT : (weight from 2,646 to 4,630 lbs)

— 21 JULY 1960 — Vergiate Airfield

<b>Height Record :</b>	(take-off weight 2,710 lbs)	23,570 ft.
<b>Speed Record</b> on 100 km. range (62 miles) (closed circuit)	(take-off weight 2,821 lbs)	167,974 mph.
<b>Speed Record</b> on 500 km. range (310 miles) (closed circuit)	(take-off weight 2,821 lbs)	167,130 mph.

CLASS C2 c SEAPLANES : (weight from 2,646 to 4,630 lbs)

— 22 JULY 1960 — Lake Maggiore

<b>Speed Record</b> on 100 km. range (62 miles) (closed circuit)	(take-off weight 2,832 lbs)	168,912 mph.
<b>Speed Record</b> on 500 km. range (310 miles) (closed circuit)	(take-off weight 2,832 lbs)	167,155 mph.
<b>Height Record</b> - 23 JULY 1960	(take-off weight 2,695 lbs)	22,789 ft.

CHIEF TEST PILOT : **Commdr. Giuseppe ALESINI.**

SOCIETÀ PER AZIONI

*Siair*

**MARCHETTI**

Management: Sesto Calende (Lago Maggiore) Italia

Factories : Vergiate  
Sesto Calende  
Borgomanero  
Malpensa

**LANE-SIRI**  
COMPANY

---

2616 West Mockingbird Lane • Dallas 35, Texas • Fleetwood 7-1132